

AMANO®

PIX-21

Electronic Time Recorder

Operation Manual

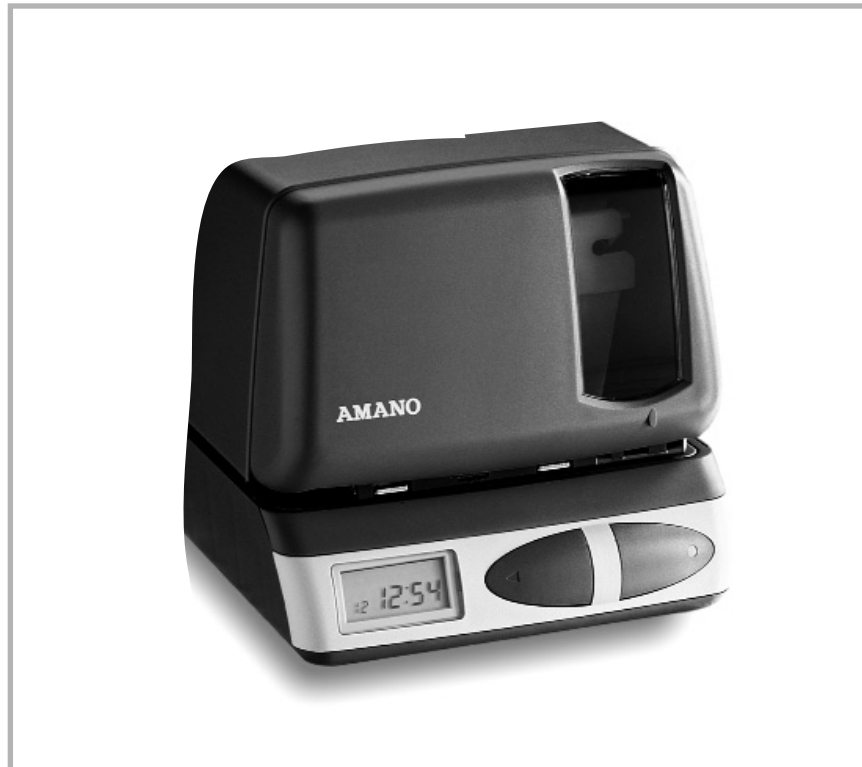

SAFETY

Installation, maintenance, etc. of this apparatus should only be performed by a qualified electrician.

PROPRIETARY NOTICE

This document contains proprietary information and such information may not be reproduced in whole or in part without the written permission from Amano Cincinnati, Inc., 140 Harrison Avenue, Roseland, New Jersey, 07068

Amano Cincinnati, Inc. reserves the right to make equipment changes and improvements which may not be reflected in this document. Portions of this document may have been updated to include the latest hardware or firmware version, if applicable.

We recommend that this document be read in its entirety before any attempt is made to operate the equipment.

Before You Begin

The Daylight Saving Time date settings have been preset. DO NOT change the Daylight Saving Time date settings unless you live in Arizona, Hawaii, parts of Indiana, or any other area that does not use Daylight Saving Time.

External View

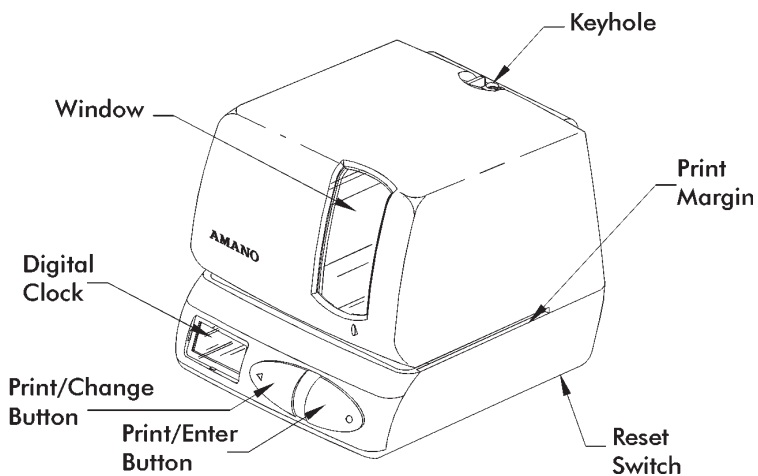

Removing the Cover & Packing Materials

1. Lift the printer block and remove the spacer.

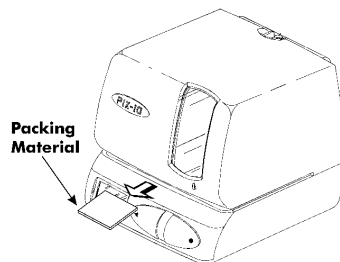

2. Insert the key provided and turn clockwise to open the case. Lift the cover to remove.

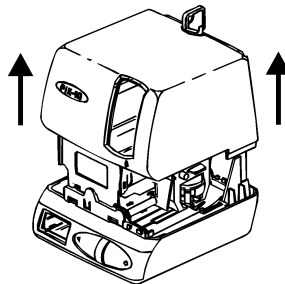

3. Remove the spacer between the Ribbon Cartridge and the Printer Carriage.
4. Re-install the cover. Your PIX-21 is ready for use!

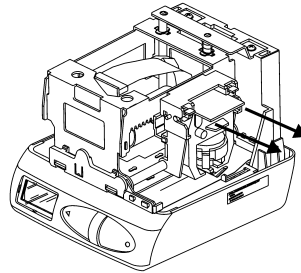

Front Panel Description

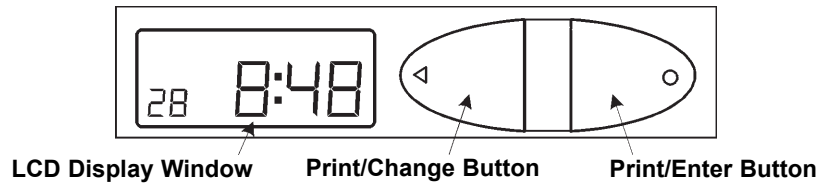

The RESET Button is located on the bottom of the clock. It is used with the CHANGE or ENTER Button to start the Program mode.

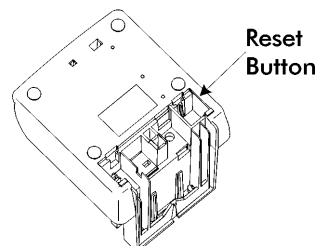

When in the Program mode, press the PRINT/CHANGE Button to change data or advance to the next menu selection.

When in the Program mode, press the PRINT/ENTER Button to accept a value or enter a selection into memory.

When in the Normal mode, the PIX-21 as a default will automatically print when a time card or piece of paper is inserted. This default can be changed in the Program mode to require both PRINT buttons to be pressed simultaneously in order to print.

Mounting the Clock

1. Remove the mounting bracket from the clock by pushing forward on the top tabs "A" and then pushing the tabs down "B" (See below).

2. If you are using the Mobile Mounting Unit gooseneck and special mounting bracket (P/N AJR-208800), mount the gooseneck to the vehicle in the desired location first. Mount the special mounting bracket to the gooseneck using the three #M5 acorn nuts and washers provided. You may discard the original PIX mounting bracket if you wish.

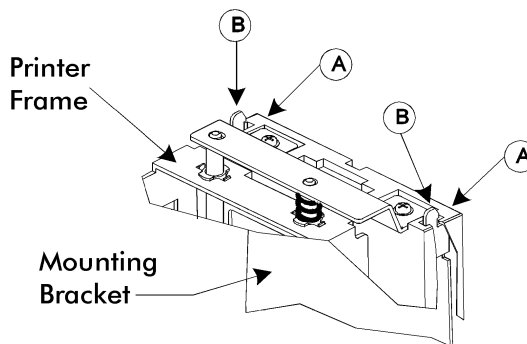

3. If you are not using the Mobile Mounting Unit, securely mount the PIX mounting bracket on the wall using three #10 wood screws or equivalent.
4. Refer to the illustration below to plug the appropriate power cord into the bottom rear of the clock.

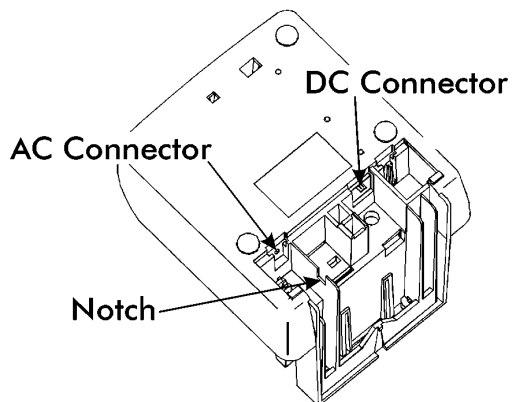

If you are using the DC power cord, locate the rubber grommet on the power cord and install the grommet into the notch in the housing. The power cord will exit the clock through the opening on the bottom. Refer to page 16 for more information about using the DC power cord.

Quick Program Mode

These instructions must be followed in the order in which they are given. The PIX-21 has two programming modes: Normal and Quick. Either mode may be accessed by simply entering a specific password. To enter the Normal programming mode, use the password "8088" and follow the instructions to program all the items. Refer to page 9 to enter the Normal mode password. For a quick setup of a particular item in the PIX-21, use the alternate password which correlates to the print style of choice. (See chart on page 5.) The "Quick" mode shortens the print style setup. Refer to page 6 to enter the Quick mode.

1. Understanding the Front Panel

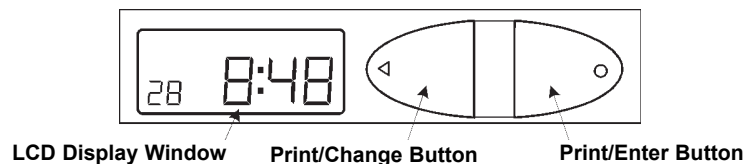

2. Plug In the Power Cord and Make a Test Print

Insert a piece of paper or time card into the PIX-21. The clock will automatically print a 4-digit YEAR, MONTH, DATE, and TIME with AM or PM.

Note: The PIX-21 will automatically adjust for Daylight Saving Time.

If these conditions are unsatisfactory, you must change the program settings.

3. The Reset Button

Press the RESET button to exit the programming mode at any time and return to the time display.

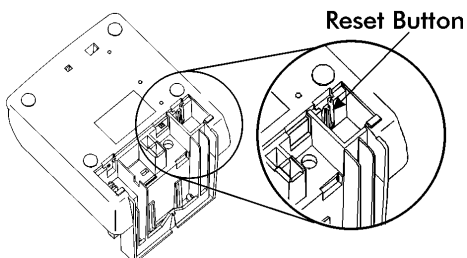

The RESET Button is located in the right lower corner on the bottom of the clock.

Chart 1 - Passwords for the Quick Program Mode







<u>Password</u>	<u>Print Style</u>	<u>Print Direction</u>
6510	DAY, 12H, 60th	Right Side Printing
6210	DAY, 24H, 10th	Right Side Printing
6810	DAY, 24H, 100th	Right Side Printing
6520	DATE, 12H, 60th	Right Side Printing
6620	DATE, 24H, 60th	Right Side Printing
6820	DATE, 24H, 100th	Right Side Printing
6540	DATE, MONTH, 12H, 60th	Right Side Printing
6640	DATE, MONTH, 24H, 60th	Right Side Printing
6840	DATE, MONTH, 24H, 100th	Right Side Printing
6680	DATE, MONTH, 2-digit YEAR, 24H, 60th	Right Side Printing
6530	MONTH, DATE, 12H, 60th	Right Side Printing
6630	MONTH, DATE, 24H, 60th	Right Side Printing
6830	MONTH, DATE, 24H, 100th	Right Side Printing
6570	2-digit YEAR, MONTH, DATE, 12H, 60th	Right Side Printing
6071	2-digit YEAR, MONTH, DATE, RCV'D	Right Side Printing
6072	2-digit YEAR, MONTH, DATE, SENT	Right Side Printing
6073	2-digit YEAR, MONTH, DATE, FAX'D	Right Side Printing
6074	2-digit YEAR, MONTH, DATE, VOID	Right Side Printing
6075	2-digit YEAR, MONTH, DATE, PAID	Right Side Printing
6076	2-digit YEAR, MONTH, DATE, CFM'D	Right Side Printing
6077	2-digit YEAR, MONTH, DATE, APR'D	Right Side Printing
6078	2-digit YEAR, MONTH, DATE, CMPL'D	Right Side Printing
6079	2-digit YEAR, MONTH, DATE, ORIGN	Right Side Printing
6070	2-digit YEAR, MONTH, DATE, FILE	Right Side Printing
6910	4 digit YEAR, MONTH, DATE, 12H, 60th	Right Side Printing
6920	4 digit YEAR, MONTH, DATE, 24H, 60th	Right Side Printing
5510	DAY, 12H, 60th	Left Side Printing
5210	DAY, 24H, 10th	Left Side Printing
5810	DAY, 24H, 100th	Left Side Printing
5520	DATE, 12H, 60th	Left Side Printing
5620	DATE, 24H, 60th	Left Side Printing
5820	DATE, 24H, 100th	Left Side Printing
5540	DATE, MONTH, 12H, 60th	Left Side Printing
5640	DATE, MONTH, 24H, 60th	Left Side Printing
5840	DATE, MONTH, 24H, 100th	Left Side Printing
5680	DATE, MONTH, 2-digit YEAR, 24H, 60th	Left Side Printing
5530	MONTH, DATE, 12H, 60th	Left Side Printing
5630	MONTH, DATE, 24H, 60th	Left Side Printing
5830	MONTH, DATE, 24H, 100th	Left Side Printing
5570	2-digit YEAR, MONTH, DATE, 12H, 60th	Left Side Printing
5071	2-digit YEAR, MONTH, DATE, RCV'D	Left Side Printing
5072	2-digit YEAR, MONTH, DATE, SENT	Left Side Printing
5073	2-digit YEAR, MONTH, DATE, FAX'D	Left Side Printing
5074	2-digit YEAR, MONTH, DATE, VOID	Left Side Printing
5075	2-digit YEAR, MONTH, DATE, PAID	Left Side Printing
5076	2-digit YEAR, MONTH, DATE, CFM'D	Left Side Printing
5077	2-digit YEAR, MONTH, DATE, APR'D	Left Side Printing
5078	2-digit YEAR, MONTH, DATE, CMPL'D	Left Side Printing
5079	2-digit YEAR, MONTH, DATE, ORIGN	Left Side Printing
5070	2-digit YEAR, MONTH, DATE, FILE	Left Side Printing
5910	4 digit YEAR, MONTH, DATE, 12H, 60th	Left Side Printing
5920	4 digit YEAR, MONTH, DATE, 24H, 60th	Left Side Printing

If you cannot locate the desired print style from the above list, change to the Normal mode and refer to the instructions for programming the print style manually.



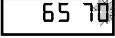

4. Entering the Quick Program Mode

The following steps describe how to get into the Quick Program mode.

Note: Please refer to Chart 1 for the password listing.

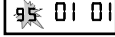

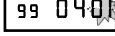

1. Press and hold down the RESET button.
2. While holding down the RESET button, press and hold down the ENTER button.
3. While holding down the ENTER button, release the RESET button.
4. When **Prog** flashes in the display, release the ENTER button. 
5. Press the ENTER button again.
6. Press the CHANGE button until the number you desire appears in the first position, then press the ENTER button. 
7. Press the CHANGE button until the number you desire appears in the second position, then press the ENTER button. 
8. Press the CHANGE button until the number you desire appears in the third position, then press the ENTER button. 
9. Press the CHANGE button until the number you desire appears in the fourth position, then press the ENTER button. 
10. When the display flashes all four numbers, press the ENTER button. 

5. Setting the Year, Month and Date

1. When the display flashes **PdRtE**, press the ENTER button. 
2. Press the CHANGE button until the correct year appears, then press the ENTER button. 
3. Press the CHANGE button until the correct month appears, then press the ENTER button. 
4. Press the CHANGE button until the correct date appears, then press the ENTER button. 
5. When the display flashes the correct year, month and date, press the ENTER button. 
6. When the display flashes **PdRtE**, press the CHANGE button to move to Setting the Time. 

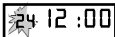

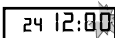
6. Setting the Time

Note: Use 24 hour and 60 minute format when setting the time.
For example: 2:00 pm = 14:00.



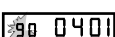
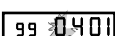
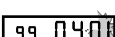

1. When the display flashes **P2 CLoc**, press the ENTER button. 
2. Press the CHANGE button to choose 12 hour AM/PM display or 24 hour military time, then press the ENTER button. 
3. Press the CHANGE button until the correct hour appears, then press the ENTER button. 
4. Press the CHANGE button until the correct minutes appear, then press the ENTER button. 
5. When the display flashes the correct time, press the ENTER button. 
6. When the display flashes **P2 CLoc**, press the CHANGE button to move to the beginning of the Daylight Saving Setting. 

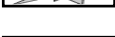
7. The Beginning of the Daylight Saving Setting

Note: The PIX-21 will automatically adjust for Daylight Saving Time. This will take effect on the first Sunday in April and on the last Sunday in October. To disable Daylight Saving Time, set the beginning date equal to the ending date.

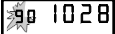
1. When the display flashes **P3 bdt**, press the ENTER button. 
2. Press the CHANGE button until the correct year appears, then press the ENTER button. 
3. Press the CHANGE button until the correct month appears, then press the ENTER button. 
4. Press the CHANGE button until the correct date appears, then press the ENTER button. 
5. When the display flashes the correct year, month and date, press the ENTER button. 
6. When the display flashes **P3 bdt**, press the CHANGE button to move to the end of the Daylight Saving Setting. 

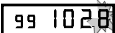
8. The End of the Daylight Saving Setting

1. When the display flashes $\overline{\text{P4}} \text{ EdL t}$, press the ENTER button. 
2. Press the CHANGE button until the correct year appears, then press the ENTER button. 
3. Press the CHANGE button until the correct month appears, then press the ENTER button. 
4. Press the CHANGE button until the correct date appears, then press the ENTER button. 
5. When the display flashes the correct year, month and date, press the ENTER button. 
6. When the display flashes $\overline{\text{P4}} \text{ EdL t}$, press the CHANGE button to move to the end of the Program. 

Note: To disable the Daylight Saving Setting, set the beginning and ending date to the same date.

9. Exit Program Mode

1. When the display flashes $\overline{\text{End}}$, press the ENTER button to exit the program mode. 

Normal Program Mode

These instructions must be followed in the order given.

1. Understanding the Front Panel

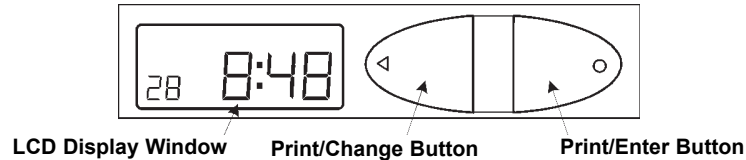

2. Plug In the Power Cord

3. The Reset Button

Note: To exit the programming mode and return to the time display, press the RESET button at any time.

The RESET Button is located in the lower right corner on the bottom of the clock.

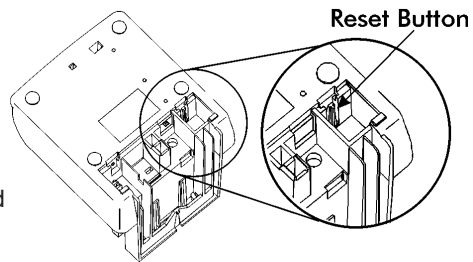





4. Entering the Normal Program Mode

The following steps describe how to get into the Normal Program mode.

Note: The password is printed inside the top of the cover case: "8088".

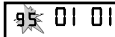

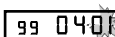

1. Press and hold down the RESET button.
2. While holding down the RESET button, press and hold down the ENTER button.
3. While holding down the ENTER button, release the RESET button.
4. When **Prog** flashes in the display, release the ENTER button. Prog
5. Press the ENTER button again.
6. Press the CHANGE button until the **B** appears in the first position, then press the ENTER button. ~~80 00~~
7. Press the CHANGE button until the **D** appears in the second position, then press the ENTER button. ~~80 00~~
8. Press the CHANGE button until the **B** appears in the third position, then press the ENTER button. ~~80 80~~
9. Press the CHANGE button until the **B** appears in the fourth position, then press the ENTER button. ~~80 88~~
10. When the display flashes **8088**, press the ENTER button. ~~80 88~~

5. Setting the Year, Month and Date

1. When the display flashes **DATE**, press the ENTER button. 
2. Press the CHANGE button until the correct year appears, then press the ENTER button. 
3. Press the CHANGE button until the correct month appears, then press the ENTER button. 
4. Press the CHANGE button until the correct date appears, then press the ENTER button. 
5. When the display flashes the correct year, month and date, press the ENTER button. 
6. When the display flashes **DATE**, press the CHANGE button to move to Setting the Time. 

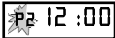

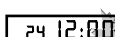
6. Setting the Time

Note: Use 24 hour and regular 60 minute format when setting the time.
For example: 2:00 PM = 14:00.



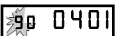
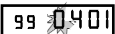
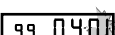

1. When the display flashes **CLoc**, press the ENTER button. 
2. Press the CHANGE button to choose 12 hour AM/PM display or 24 hour military time, then press the ENTER button. 
3. Press the CHANGE button until the correct hour appears, then press the ENTER button. 
4. Press the CHANGE button until the correct minutes appear, then press the ENTER button. 
5. When the display flashes the correct time, press the ENTER button. 
6. When the display flashes **CLoc**, press the CHANGE button to move to the beginning of the Daylight Saving Setting. 

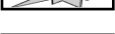
7. The Beginning of the Daylight Saving Setting

Note: The PIX-21 will automatically adjust for Daylight Saving Time. This will take effect on the first Sunday in April and on the last Sunday in October. To disable Daylight Saving Time, set the beginning date equal to the ending date.



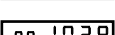
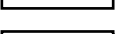

1. When the display flashes $\overline{P3} \text{ bdlE}$, press the ENTER button. 
2. Press the CHANGE button until the correct year appears, then press the ENTER button. 
3. Press the CHANGE button until the correct month appears, then press the ENTER button. 
4. Press the CHANGE button until the correct date appears, then press the ENTER button. 
5. When the display flashes the correct year, month and date, press the ENTER button. 
6. When the display flashes $\overline{P3} \text{ bdlE}$, press the CHANGE button to move to the end of the Daylight Saving Setting. 

8. The End of the Daylight Saving Setting

1. When the display flashes $\overline{P4} \text{ EdLE}$, press the ENTER button. 
2. Press the CHANGE button until the correct year appears, then press the ENTER button. 
3. Press the CHANGE button until the correct month appears, then press the ENTER button. 
4. Press the CHANGE button until the correct date appears, then press the ENTER button. 
5. When the display flashes the correct year, month and date, press the ENTER button. 
6. When the display flashes $\overline{P4} \text{ EdLE}$, press the CHANGE button to move to Setting the Print Style. 

9. Setting the Print Style

Note: The maximum printed line length equals 152 dots across.
Please refer to the chart below for codes representing the print styles, number of dots and line lengths. Refer to page 14 for sample print styles.

1. When the display flashes **PS P5:L**, press the ENTER button. 
2. Press the CHANGE button until the correct character code you want to print appears, then press the ENTER button. 
3. Press the CHANGE button until the next correct character code you want appears, then press the ENTER button. 
4. When you have entered the print format you want, press the CHANGE button until the En character flashes, then press the ENTER button. 
5. When the display flashes **PS P5:L**, press the CHANGE button to move to the Language Setting. 

<u>Symbol Code</u>	<u>LCD Display</u>	<u>Character</u>	<u># of Dots = % of Line</u>
		'95 APR 10 pm 1:28	
a	YEAR	2-digit Year	25 = 16.45%
m	on:h	Month	30 = 19.74%
d	AR:E	Date	20 = 13.16%
d	AY	Day	20 = 13.16%
J	LAR	Julian Date	30 = 19.74%
12	10:h	12HR. & 10th/HR.	49 = 32.24%
12	20:h	12HR. & 20th/HR.	59 = 38.82%
12	60:h	12HR. & 60th/HR.	59 = 38.82%
12	100:h	12HR. & 100th/HR.	59 = 38.82%
24	10:h	24HR. & 10th/HR.	35 = 23.03%
24	20:h	24HR. & 20th/HR.	45 = 29.61%
24	60:h	24HR. & 60th/HR.	45 = 29.61%
24	100:h	24HR. & 100th/HR.	45 = 29.61%
S	L Sh	Slash (/)	10 = 6.58%
d	ASH	Dash (-)	07 = 4.61%
S	PCE	Space ()	03 = 1.97%
w	YEAR	4-digit Year	28 = 14.00%
S	- 1	RCV'D	43 = 28.29%
S	- 2	SENT	40 = 26.32%
S	- 3	FAX'D	43 = 28.29%
S	- 4	VOID	40 = 26.32%
S	- 5	PAID	40 = 26.32%
S	- 6	CFM'D	43 = 28.29%
S	- 7	APR'D	43 = 28.29%
S	- 8	CMPL'D	53 = 34.87%
S	- 9	ORIGN	50 = 32.89%
S	- 0	FILE	40 = 26.32%
	En	End of File	-----
	Ad	Add a Character	-----
	dL	Delete a Character	-----

Print Line Length Calculation: Max. Length = 152 Dots; Percentage = [(Number of Dots) / 152 Dots] x 100

10. Setting the Language

1. When the display flashes P6 LAng , press the ENTER button.
2. Press the CHANGE button until the correct language appears, then press the ENTER button.
3. When the display flashes P6 LAng , press the CHANGE button to move to the Print Direction.



Please refer to the Language Table for selections.

Language Table

English =	French =	Italian =	Roman =	Common =
L1 Eng	L3 Frn	L5 ItY	L7 rom	L9 Com
Spanish =	German =	Portuguese =	Japanese =	
L2 SPn	L4 GER	L6 PE9	L8 JPN	

11. Setting the Print Direction

1. When the display flashes P7 Prdr , press the ENTER button.
2. Press the CHANGE button until the correct direction appears, then press the ENTER button.



Right Side Printing = r h9 t **Left Side Printing =** LEF t

3. When the display flashes P7 Prdr , press the CHANGE button to move to the Auto Print Setting.



12. Setting the Auto Print

1. When the display flashes P8 APrt , press the ENTER button.
2. Press the CHANGE button until the correct printing mode appears, then press the ENTER button.



on P (Auto Print) allows you to print automatically by activating the paper detect switch.

OFF (Manual Print) allows you to print whenever the PRINT buttons are pushed.

on P:5 (Precision Print) requires you to activate the paper detect switch while pressing the PRINT buttons.

3. When the display flashes P8 APrt , press the CHANGE button to move to the Leading Zero Setting.



13. Setting the Leading Zero On or Off

Note: The leading Zero appears on the print out before single digit times and dates (for example: DEC. 06, 08:00).

1. When the display flashes **P9 2Er0**, press the ENTER button.



2. When the display flashes **OFF** or **on**, pressing the CHANGE button will alternate between off and on. Press the ENTER button to select.



3. When the display flashes **P9 2Er0**, press the CHANGE button to move to the Diagnostics Mode.



14. Diagnostics Mode

See page 16 for a description of the Diagnostics Routine.

15. Exit Program Mode

1. Press the CHANGE button until the display flashes **End**, then press the ENTER button.



Sample Print Style Code List

Print Style	Imprint Style	Code to Enter	Total Dot Length
DAY, 12H, 60th	FRI PM 1:45	dAY SPCE 1260:h	82 dots
DAY, 24H, 60th	FRI 13:45	dAY SPCE 2460:h	68 dots
DAY, 24H, 10th	FRI 13.7	dAY SPCE 2410:h	58 dots
DAY, 24H, 100th	FRI 13.75	dAY SPCE 24100h	68 dots
DATE, 12H, 60th	13 PM 1:45	dA:E SPCE 1260:h	82 dots
DATE, 24H, 60th	13 13:45	dA:E SPCE 2460:h	68 dots
DATE, 24H, 10th	13 13.7	dA:E SPCE 2410:h	58 dots
DATE, 24H, 100th	13 13.75	dA:E SPCE 24100h	68 dots
MONTH, DATE, 12H, 60th	APR 13 PM 1:45	mo:th SPCE dA:E SPCE 1260:h	115 dots
MONTH, DATE, 24H, 60th	APR 13 13:45	mo:th SPCE dA:E SPCE 2460:h	101 dots
MONTH, DATE, 24H, 10th	APR 13 13.7	mo:th SPCE dA:E SPCE 2410:h	91 dots
MONTH, DATE, 24H, 100th	APR 13 13.75	mo:th SPCE dA:E SPCE 24100h	101 dots
2dYEAR, MONTH, DATE, 12H, 60th	'95 APR 13 PM 1:45	2dYEAR SPCE mo:th SPCE dA:E SPCE 1260:h	143 dots
2dYEAR, MONTH, DATE, 24H, 60th	'95 APR 13 13:45	2dYEAR SPCE mo:th SPCE dA:E SPCE 2460:h	129 dots
2dYEAR, MONTH, DATE, 24H, 10th	'95 APR 13 13.7	2dYEAR SPCE mo:th SPCE dA:E SPCE 2410:h	119 dots
2dYEAR, MONTH, DATE, 24H, 100th	'95 APR 13 13.75	2dYEAR SPCE mo:th SPCE dA:E SPCE 24100h	129 dots
2dYEAR, MONTH, DATE, SYMBOL1	'95 APR 13 RCVD	2dYEAR SPCE mo:th SPCE dA:E SPCE 59-1	127 dots
2dYEAR, MONTH, DATE, SYMBOL2	'95 APR 13 SENT	2dYEAR SPCE mo:th SPCE dA:E SPCE 59-2	124 dots
2dYEAR, MONTH, DATE, SYMBOL3	'95 APR 13 FAX'D	2dYEAR SPCE mo:th SPCE dA:E SPCE 59-3	127 dots
2dYEAR, MONTH, DATE, SYMBOL4	'95 APR 13 PAID	2dYEAR SPCE mo:th SPCE dA:E SPCE 59-4	124 dots

Replacing the Ribbon

To Remove:

1. Pull the two catches upward "B" and hold with index and middle fingers. Remove the ribbon cassette.

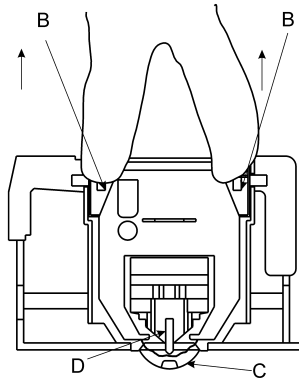

To Insert:

1. If the print mechanism is down and a piece of paper cannot be inserted, press the RESET button to move the carriage up. This will make the ribbon installation easier.
2. Insert a new ribbon between the ribbon guide (C) and the printer head (D).
3. Turn the knob on the cassette clockwise one turn to take up any slack in the ribbon.
4. Replace the cover.
5. Check the printing quality to confirm that you have installed the ribbon properly.

Adjusting the Margin

1. Remove the Mounting Bracket.
2. Locate the Card Stopper Adjustment Screw behind the Wall Mounting Bracket on the bottom of the machine.
3. Position a piece of paper or time card and adjust the screw accordingly. The print margin can be adjusted a maximum of 22mm (7/8"). There are ruler markings on both sides of the base plate to help you align the card.

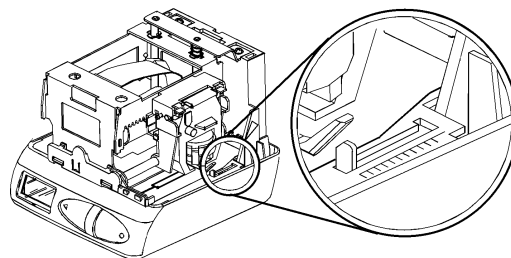
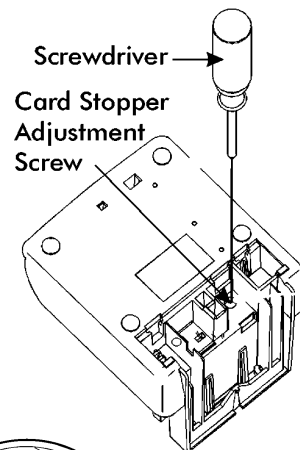









Using the DC Power Cord

1. The DC version of the PIX-21 is meant to be used only in motor vehicles with a 12-volt negative ground electrical system.
2. Power to the cigarette lighter should be present with the ignition key in the "off" position. If this is not known, it can be easily determined by plugging in the PIX-21 power cord and observing the LED in the cigarette lighter plug. If power is not present, the internal lithium battery will be prematurely depleted.
3. If the vehicle will not be used for more than one week, we recommend that the PIX-21 be removed from the vehicle and powered using the optional AC adapter. Use with the AC adapter will prevent premature depletion of the internal lithium battery. The lithium battery maintains the PIX-21 memory only for brief periods, such as a power failure or during relocation of the unit.

Using the Diagnostic Routine

The diagnostic routine checks the LCD segments, the number of prints, and the memory clear (Print Style, Language, Leading Zero Suppress, Right/Left Print and Daylight Saving Time features).

1. When the display flashes **Pr dIAG**, press the ENTER button. 
2. When the display flashes **dI Lcd** (LCD segments check), press the ENTER button. 
3. When all of the LCD segments are turned on, press the ENTER button to advance to the next step.
4. When the display flashes **d2 nPr t** (total number of prints), press the ENTER button. 
5. The number of prints counted will be displayed. Press the ENTER, then CHANGE button to advance to the next step.
6. When the display flashes **d3 CLR** (memory clear), press the ENTER button. 
7. To clear the memory and reset the defaults, press the CHANGE button until the number 3 appears, then press the ENTER button. Press the CHANGE button until the number 2 appears, then press the ENTER button. 

8. When the display flashes **32**, press the ENTER button. 
9. Press the CHANGE button until the display flashes **End**, then press ENTER. 

Error Messages

Possible Error Messages:

Home sensor, motor carriage stuck	E1 P r L	Timing sensor carriage stuck	E2 P r L	Home sensor	E3 P r L
Carriage stuck	E4 P r L	General print error	E r P r L	Daylight saving time program	d L L

For error messages E1 through E4, turn off the power before checking to see that the carriage is not stuck or jammed. Also, check to see that the ribbon cables are in good condition. After clearing any jams, restore the power and press the RESET button.

The **d L L** error message signifies that an attempt was made to get into the Program mode during the daylight saving changeover one-hour lockout. Wait one hour and you will be able to program the clock.

Maintenance

To keep your PIX-21 operating smoothly, periodically clean the printer shafts with alcohol and a cotton swab.

Clean the outside of the PIX-21 using a soft cloth, if necessary.

Specifications

Power Requirements:	For PIX-21 Input:	AC16.5V, 60Hz, 0.6A (Max.)
	For AC Adapter:	AC120V ± 10%, 60Hz AC230V ± 10%, 50Hz AC240V ± 10%, 50Hz
	For DC Adapter:	DC12V (See page 16) (Negative ground only).

Ambient Temperature: -10°C~45°C (14°F~113°F)

Ambient Humidity: 10%~90% (no condensation)

Dimensions: 140mm (W) x 150mm (H) x 165mm (D)
(5½" x 6" x 6½")

Weight: 1.8Kg (4.2lbs.)

Environment: Indoor use only; dust-free environment
Keep out of direct sunlight

For PIX-21 with 120V AC Adapter:

Listed and Certified by Underwriters Laboratories, Inc. E50230





AMANO CININNATI, INC.

140 Harrison Avenue, Roseland, NJ 07068

Atlanta Sales Office

(770) 587-1082 (800) 554-1031

Chicago Sales Office

(874) 718-1100 (800) 323-8864

Cincinnati Sales Office

(513) 697-9000 (800) 842-6266

Dallas Sales Office

(972) 556-0015 (800) 527-4037

Los Angeles Sales Office

(714) 970-2280 (800) 854-5977

New Jersey Sales Office

(973) 403-1900 (800) 526-2559

Toronto Sales Office

(905) 624-4085 (800) 387-3388